



# SERVICE BULLETIN

October, 2023      Subject: **Suspension Spring Chart**

No. **2024-2**

MODEL YEAR	MODEL
2024	All Ski-Doo

This bulletin is divided into 3 main sections:

### Section 1: Spring Identification

- Spring identification guideline. Gives information on color codes, part number and spring shape.

### Section 2: Spring Applications

- Quick reference chart which provides authorized spring application for each Ski-Doo model. It contains the standard spring part number (in gray shading) as installed at the factory, as well as 1 softer spring and 1 harder spring recommendation.

### Section 3: Spring Specifications

- Refers to spring specifications table.

# SECTION 1: SPRING IDENTIFICATION

## Coil Spring Identification

Spring identification is done by color code stripes or by its part number printed on the spring with white ink within the first 1-1/4 coils.

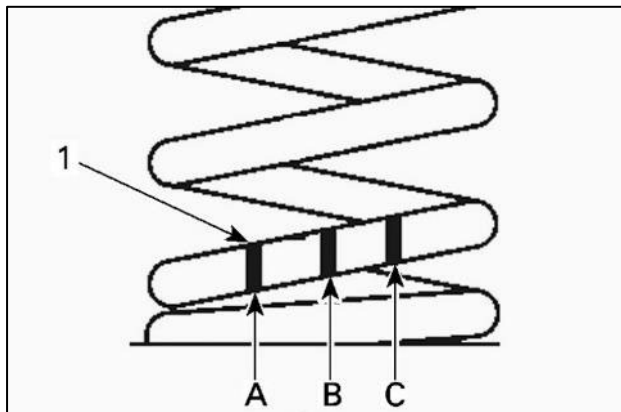

### IDENTIFICATION BY COLOR STRIPES

1. Color Stripes when spring is upright with the stripes down

- A. 1<sup>st</sup> stripe
- B. 2<sup>nd</sup> stripe
- C. 3<sup>rd</sup> stripe

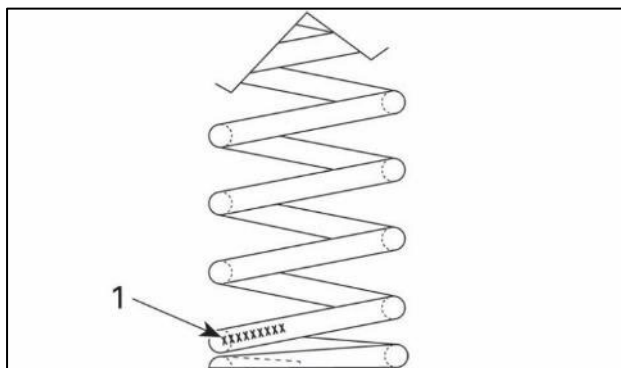

### IDENTIFICATION BY THE SPRING PART NUMBER

1. Part Number

### Color Code Legend

COLOR CODE					
BL	—	BLUE	PI	—	PINK
BK	—	BLACK	RD	—	RED
GD	—	GOLD	SI	—	SILVER
GN	—	GREEN	WH	—	WHITE
OR	—	ORANGE	YL	—	YELLOW

## Coil Spring Types

All call-outs below each following illustrations (except torsion springs) refer to:

1. Color code stripes
2. Wire diameter
3. Free length
4. Positioning tab (where applicable).

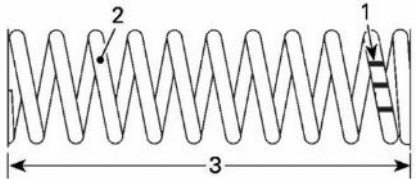
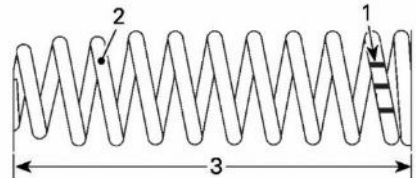
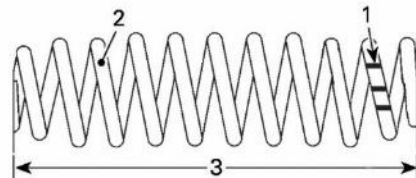
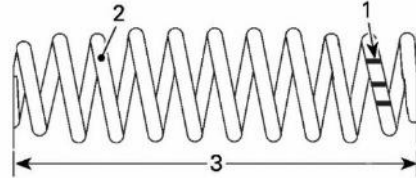
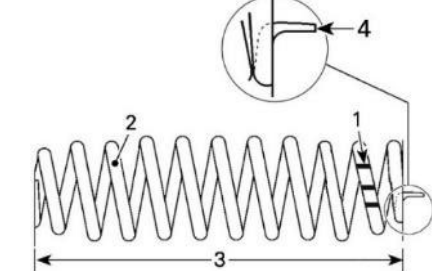
Spring type		
<p>Type R (straight at both ends)</p>	<p>Single Rate Spring</p>	
<p>Type S (barrel shape at one end)</p>	<p>Single Rate Spring</p>	
<p>Type T (barrel shape at both ends)</p>	<p>Single Rate Spring</p>	
<p>Type V (barrel shape at both ends)</p>	<p>Single Rate Spring</p>	
<p>Type Y (barrel shape at both ends with positioning tab at the identification code coils end)</p>	<p>Single Rate Spring</p>	

Spring type		
<p>Type Z (barrel shape at both ends with positioning tab at identification code coils end and 2 different diameter ends)</p>	<p>Single Rate Spring</p>	
<p>Type 2 (barrel shape at both ends)</p>	<p>Dual Rate Spring</p>	

## Torsion Spring Identification

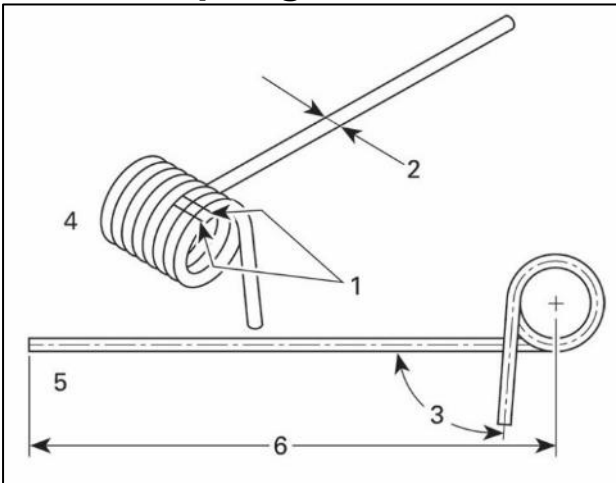

### IDENTIFICATION BY COLOR STRIPES

1. Color code stripes
2. Wire diameter
3. Opening angle (°)
4. Left hand (LH)
5. Right hand (RH)
6. Length

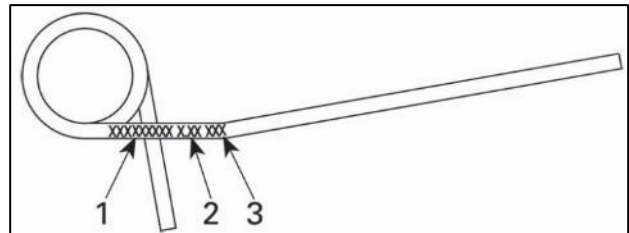

### IDENTIFICATION BY THE SPRING PART NUMBER

1. Part Number
2. Spring rate
3. Angle dimension

### Color Code Legend

COLOR CODE					
BL	—	BLUE	PI	—	PINK
BK	—	BLACK	RD	—	RED
GD	—	GOLD	SI	—	SILVER
GN	—	GREEN	WH	—	WHITE
OR	—	ORANGE	YL	—	YELLOW

Spring identification is done by color code stripes (as shown above) **or** by its part number printed on the spring with white ink (as shown below).

## SECTION 2: SPRING APPLICATIONS

### FRONT SPRINGS

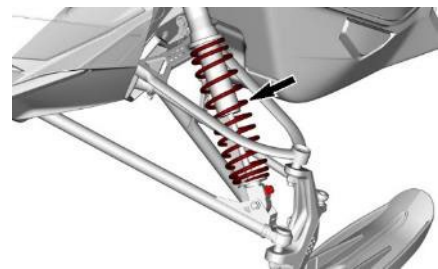

MODEL	(PART NUMBER) SOFTER	(PART NUMBER) STANDARD	(PART NUMBER) FIRMER
<b>FREERIDE SERIES</b>			
FREERIDE 146 – 154 – 165	N.A.	505072760	505074047
<b>GRAND TOURING SERIES</b>			
GRAND TOURING SPORT 600 ACE (EUR)	505074389	505074687	N.A.
GRAND TOURING SPORT 600 ACE (CAN/ USA)/ 900 ACE GRAND TOURING ELECTRIC	505073265	505074389	505074687
GRAND TOURING LIMITED 900 ACE	505074293	505075036	505074391
GRAND TOURING LIMITED 900 ACE TURBO	505075036	505075037	N.A.
<b>MXZ SERIES</b>			
MXZ NEO/ NEO+	505075035	505073265 (NEO) 505074293 (NEO+)	505075036
MXZ SPORT (EUR)	505074389	505074687	N.A.
MXZ SPORT (CAN/ USA)	505073265	505074389	505074687
MXZ BLIZZARD 600R E-TEC/ 850 E-TEC	505074293	505074309	505074391
MXZ X-RS 600R E-TEC / 850 E-TEC / TURBO R WITHOUT SMART-SHOX	505073262	505074047	505075216
MXZ X-RS 850 E-TEC WITH SMART- SHOX	N.A.	505074865	505075194
MXZ X-RS COMP 600R	505074047	505075216	505073272
<b>RENEGADE SERIES</b>			
RENEGADE SPORT 600 ACE (CAN / USA) / 600 EFI	505073265	505074389	505074687
RENEGADE SPORT 600 ACE (EUR)	505074389	505074687	N.A.
RENEGADE X 600R E-TEC/ 850 E-TEC	505072741	505074046	505074390
RENEGADE ADRENALINE 900 ACE (CAN/ USA)/ ADRENALINE 850 E-TEC/ ENDURO 900 ACE / ENDURO 600R E-TEC/ 850 E-TEC	505074293	505075036	505074391
RENEGADE ADRENALINE 900 ACE TURBO/ RENEGADE ENDURO 900 ACE TURBO/ RENEGADE ADRENALINE 900 ACE (EUR)	505075036	505075037	N.A.
RENEGADE X 900 ACE TURBO	505074046	505074390	505073272
RENEGADE X-RS 900 ACE TURBO	505074309	505074391	N.A.

## FRONT SPRINGS

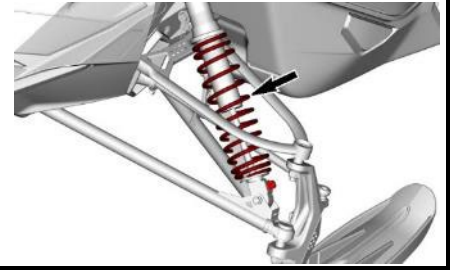

MODEL	(PART NUMBER) SOFTER	(PART NUMBER) STANDARD	(PART NUMBER) FIRMER
RENEGADE X-RS 900 ACE TURBO WITH SMART-SHOX	505074865	505075194	N.A.
<b>BACKCOUNTRY SERIES</b>			
BACKCOUNTRY SPORT (EUR)	505074389	505074687	N.A.
BACKCOUNTRY SPORT (CAN/ USA)	505073265	505074389	505074687
BACKCOUNTRY X	505074048	505072741	505074046
BACKCOUNTRY (CAN/ USA)	505075035	505075484	505075036
BACKCOUNTRY (EUR)	505075484	505075036	505075037
BACKCOUNTRY X-RS	505074293	505074309	505074391
<b>SUMMIT SERIES</b>			
SUMMIT NEO/ NEO+	N.A.	505074049	505075036
SUMMIT 600R E-TEC/ 850 E-TEC SUMMIT EDGE 850 E-TEC SUMMIT ADRENALINE	N.A.	505075035	505074309
SUMMIT X 850 E-TEC/ TURBO	N.A.	505075413	505074046
SUMMIT EXPERT 850 E-TEC/ TURBO	505075321	505075402	N.A.
<b>EXPEDITION SERIES</b>			
EXPEDITION SPORT 600 EFI/ 600 ACE/ 900 ACE (CAN/ USA/ ASIA)	505073265	505074389	505074687
EXPEDITION XTREME	505072741	505074046	505074390
EXPEDITION SPORT 600 EFI / 900 ACE (EUR) EXPEDITION LE/ SE 600R / 900 ACE/ TURBO	505074309	505075037	N.A.
<b>SKANDIC SERIES</b>			
SKANDIC SPORT/ LE/ SE	505072557	505072745	505073204
<b>TUNDRA SERIES</b>			
TUNDRA SPORT/ LT	N.A.	505072557	505072745

## CENTER SPRINGS

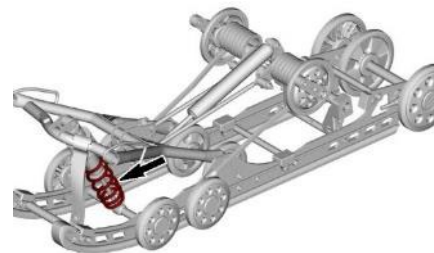

MODEL	(PART NUMBER) SOFTER	(PART NUMBER) STANDARD	(PART NUMBER) FIRMER
<b>FREERIDE SERIES</b>			
FREERIDE 146 – 154 – 165	N.A.	503195913	N.A.
<b>GRAND TOURING SERIES</b>			
GRAND TOURING SPORT 600 ACE/ 900 ACE	503191879	503191882	503191880
GRAND TOURING ELECTRIC	503191880	503189686	N.A.
GRAND TOURING LIMITED 900 ACE/ 900 ACE TURBO	503193837 503193067	503193837 503193160	503191343 503192279
<b>MXZ SERIES</b>			
MXZ NEO/ NEO+ (TORSION SPRINGS)	N.A.	503196895 (RIGHT) 503196896 (LEFT)	N.A.
MXZ SPORT / BLIZZARD / X	N.A.	503195855	503191343 503192279 503191281
MXZ X-RS MXZ X-RS COMP TURBO R	503196469 503193065	503193479 503193065	503192724 503192744
MXZ X-RS COMP 600R	503193479 503193065	503193479 503193113	503192744 503192724
<b>RENEGADE SERIES</b>			
RENEGADE SPORT	503191879	503191882	503191880
RENEGADE ENDURO E-TEC	N.A.	503195855	503191343 503192279 503191281
RENEGADE X 900 ACE TURBO/ ADRENALINE 900 ACE/ 900 ACE TURBO/ ENDURO 900 ACE/ 900 ACE TURBO	503193837 503193067	503193837 503193160	503191343 503192279
RENEGADE X-RS 900 ACE TURBO	503196469 503193065	503193479 503193065	503192724 503192744
<b>BACKCOUNTRY SERIES</b>			
BACKCOUNTRY SPORT	N.A.	503195855	503191343 503192279 503191281
BACKCOUNTRY X-RS	N.A.	503195913	N.A.
BACKCOUNTRY BACKCOUNTRY X	503191879	503191882	503191880

## CENTER SPRINGS

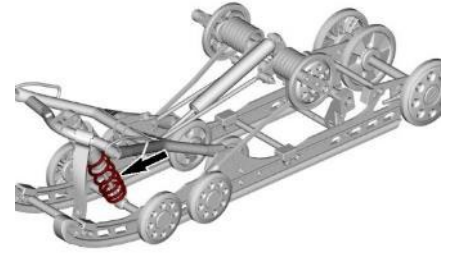

MODEL	(PART NUMBER) SOFTER	(PART NUMBER) STANDARD	(PART NUMBER) FIRMER
<b>SUMMIT SERIES</b>			
SUMMIT NEO/ NEO+	N.A.	503196895 (LEFT) 503196896 (RIGHT)	503195606 (LEFT) 503195607 (RIGHT)
SUMMIT SP/ EDGE	503191879	503191882	503191880
SUMMIT X	N.A.	503195465	503195516
SUMMIT EXPERT	N.A.	503195465	503195516
<b>EXPEDITION SERIES</b>			
EXPEDITION SPORT 600 EFI/ 600 ACE (ASIA)	503191879	503191882	503191880
EXPEDITION SPORT 600 ACE (CAN/ USA)/ 900 ACE (CAN/ USA)	503191882	503191880	503189686
EXPEDITION SPORT 600 EFI/ 900 ACE (EUR)	N.A.	503195855	503191343 503192279 503191281
EXPEDITION LE/ SE/ EXTREME	503193837 503193067	503193837 503193160	503191343 503192279
<b>SKANDIC SERIES</b>			
SKANDIC SPORT/ LE/ SE	503191882	503191880	503189686
<b>TUNDRA SERIES</b>			
TUNDRA SPORT	503191879	503191882	503191880
TUNDRA LT	503191882	503191880	503189686

## REAR SPRINGS



MODEL	(PART NUMBER) SOFTER	(PART NUMBER) STANDARD	(PART NUMBER) FIRMER
<b>FREERIDE SERIES</b>			
FREERIDE 146 – 154 – 165	503193637 (RIGHT) 503193636 (LEFT)	503196942 (RIGHT) 503196941 (LEFT)	503192270 (RIGHT) 503192271 (LEFT)
<b>GRAND TOURING SERIES</b>			
GRAND TOURING SPORT (CAN/ USA)	503191287 (RIGHT) 503191289 (LEFT)	503192270 (RIGHT) 503192271 (LEFT)	503191247 (RIGHT) 503191249 (LEFT)
GRAND TOURING SPORT 600 ACE (EUR)	503192270 (RIGHT) 503192271 (LEFT)	503193538 (RIGHT) 503193539 (LEFT)	503191481 (RIGHT) 503191483 (LEFT)
GRAND TOURING LIMITED	503192270 (RIGHT) 503192271 (LEFT)	503196202 (RIGHT) 503196203 (LEFT)	503191481 (RIGHT) 503191483 (LEFT)
GRAND TOURING ELECTRIC	503191614 (RIGHT) 503191615 (LEFT)	503191616 (RIGHT) 503191617 (LEFT)	503191892 (RIGHT) 503191893 (LEFT)
<b>MXZ SERIES</b>			
MXZ NEO/ NEO+	503196052 (LEFT)	503192271 (LEFT)	503196202 (LEFT)
MXZ SPORT	503192080 (RIGHT) 503192081 (LEFT)	503193159 (RIGHT) 503193158 (LEFT)	503192270 (RIGHT) 503192271 (LEFT)
MXZ X-RS/ BLIZZARD	503193159 (RIGHT) 503193158 (LEFT)	503196053 (RIGHT) 503196052 (LEFT)	503196202 (RIGHT) 503196203 (LEFT)
MXZ X-RS COMP	N.A.	503195812 (RIGHT) 503195813 (LEFT)	503196202 (RIGHT) 503196203 (LEFT)
<b>RENEGADE SERIES</b>			
RENEGADE SPORT (EUR)/ RENEGADE ADRENALINE (EUR)	503193159 (RIGHT) 503193158 (LEFT)	503192270 (RIGHT) 503192271 (LEFT)	503193538 (RIGHT) 503193539 (LEFT)
RENEGADE SPORT (CAN/ USA)/ RENEGADE ENDURO	503192080 (RIGHT) 503192081 (LEFT)	503193159 (RIGHT) 503193158 (LEFT)	503192270 (RIGHT) 503192271 (LEFT)
RENEGADE X/ X-RS/ ADRENALINE (CAN/ USA)	503193159 (RIGHT) 503193158 (LEFT)	503196053 (RIGHT) 503196052 (LEFT)	503196202 (RIGHT) 503196203 (LEFT)
<b>BACKCOUNTRY SERIES</b>			
BACKCOUNTRY SPORT (CAN/USA)	503192080 (RIGHT) 503192081 (LEFT)	503193159 (RIGHT) 503193158 (LEFT)	503192270 (RIGHT) 503192271 (LEFT)
BACKCOUNTRY SPORT (EUR)	503193159 (RIGHT) 503193158 (LEFT)	503192104 (RIGHT) 503192105 (LEFT)	503192270 (RIGHT) 503192271 (LEFT)
BACKCOUNTRY ADRENALINE/ X/ X-RS	503193636 (RIGHT) 503193637 (LEFT)	503196942 (RIGHT) 503196941 (LEFT)	503192270 (RIGHT) 503192271 (LEFT)

## REAR SPRINGS

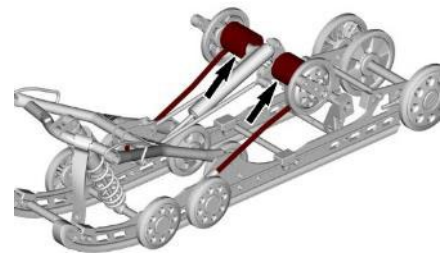

MODEL	(PART NUMBER) SOFTER	(PART NUMBER) STANDARD	(PART NUMBER) FIRMER
<b>SUMMIT SERIES</b>			
SUMMIT NEO/ NEO+	503196052 (LEFT)	503192271 (LEFT)	503196202 (LEFT)
SUMMIT SP/ X/ EDGE/ EXPERT	503193636 (RIGHT) 503193637 (LEFT)	503196942 (RIGHT) 503196941 (LEFT)	503192270 (RIGHT) 503192271 (LEFT)
<b>EXPEDITION SERIES</b>			
EXPEDITION SPORT 600 EFI/ 600 ACE/ 900 ACE (CAN/ USA/ ASIA)	503191287 (RIGHT) 503191289 (LEFT)	503192270 (RIGHT) 503192271 (LEFT)	503191247 (RIGHT) 503191249 (LEFT)
EXPEDITION SPORT 900 ACE (EUR)	503192270 (RIGHT) 503192271 (LEFT)	503193538 (RIGHT) 503193539 (LEFT)	503191481 (RIGHT) 503191483 (LEFT)
EXPEDITION LE 20"	503194340 (RIGHT) 503194341 (LEFT)	503192377 (RIGHT) 503192378 (LEFT)	503192910 (RIGHT) 503192911 (LEFT)
EXPEDITION SE/ EXTREME	N.A.	503194340 (RIGHT) 503194341 (LEFT)	503192377 (RIGHT) 503192378 (LEFT)
EXPEDITION LE 24"	503192377 (RIGHT) 503192378 (LEFT)	503192910 (RIGHT) 503192911 (LEFT)	N.A.
<b>SKANDIC SERIES</b>			
SKANDIC SPORT (CAN/ USA)	N.A.	503194340 (RIGHT) 503194341 (LEFT)	503192377 (RIGHT) 503192378 (LEFT)
SKANDIC SPORT (EUR)/ LE/ SE 20"	503194340 (RIGHT) 503194341 (LEFT)	503192377 (RIGHT) 503192378 (LEFT)	503192910 (RIGHT) 503192911 (LEFT)
SKANDIC LE/ SE 24"	503192377 (RIGHT) 503192378 (LEFT)	503192910 (RIGHT) 503192911 (LEFT)	N.A.
<b>TUNDRA SERIES</b>			
TUNDRA SPORT	503193637 (RIGHT) 503193636 (LEFT)	503192080 (RIGHT) 503192081 (LEFT)	503192270 (RIGHT) 503192271 (LEFT)
TUNDRA LT	503192080 (RIGHT) 503192081 (LEFT)	503192137 (RIGHT) 503192136 (LEFT)	503192270 (RIGHT) 503192271 (LEFT)

# SECTION 3: SPRING SPECIFICATIONS

## Coil Spring Specifications

(PART NUMBER)	TYPE	SPRING RATE (LB/IN) ±10	FREE LENGTH (MM) ±3	WIRE DIAMETER (MM) ±.05	COLOR CODE	COLOR OF SPRING
503189686	T	200	242	9.19	RD/SI/YL	BLACK
503191343	R	223	56	5.94	SI/RD/RD	BLACK
503191879	T	135	242	7.49	detail "A" WH/WH/OR	BLACK
503191880	T	180	242	8.25	-	BLACK
503191882	T	150	242	7.77	-	BLACK
503192279	T	275	184	8.71	-	BLACK
503192724	S	275	155	9.19	-	BLACK
503192744	R	222	59	6.17	-	BLACK
503193065	S	190	162	8.25	-	BLACK
503193067	S	190	189	7.92	-	BLACK
503193160	V	275	189	9.19	-	BLACK
503193479	R	197	52	5.94	-	BLACK
503193837	R	178	51	5.94	-	BLACK
503194182	Z	150	242	7.49	-	BLACK
503194990	U	180	242	8.25	-	BLACK
503195465	U	150	240	7.29	-	BLACK
503195516	V	180	240	7.92	-	BLACK
503195855	7	92/190	242	7.92	-	BLACK
503195913	S	150	218	7.49	-	BLACK
505072557	T	70	263	5.94	-	BLACK
505072741	Z	90	280	7.49	-	BLACK
505072745	T	60	263	6.17	-	BLACK
505073204	T	88	266	6.65	-	BLACK
505073265	T	90	280	7.92	-	BLACK
505074046	Z	105	280	8.25	-	BLACK
505074048	Z	80	280	7.29	-	BLACK
505074293	V	90	280	7.92	-	BLACK
505074309	V	105	280	8.41	-	BLACK
505074389	T	105	300	8.41	-	BLACK
505074390	Z	120	280	8.71	-	BLACK
505074391	V	120	280	8.71	-	BLACK
505074687	T	120	300	8.71	-	BLACK
505074708	Z	80	240	6.81	-	BLACK
505074709	V	80	278	6.81	-	BLACK
505075036	T	105	280	8.41	-	BLACK
505075037	T	120	280	8.71	-	BLACK
505075194	V	120	280	8.71	-	BLACK
503196469	R	103	52	4.6	-	BLACK
505075321	Z	80	240	6.65	-	BLACK
505074865	V	105	280	8.25	-	BLACK
505075402	Z	90	240	6.81	-	BLACK

(PART NUMBER)	TYPE	SPRING RATE (LB/IN) ±10	FREE LENGTH (MM) ±3	WIRE DIAMETER (MM) ±.05	COLOR CODE	COLOR OF SPRING
505075413	Z	80	280	6.81	–	BLACK
505075484	T	90	280	7.49	–	BLACK

## Torsion Spring Specifications

Torsion Springs for SC-5M, cMotion, tMotion and rMotion Suspensions

(PART NUMBER)	WIRE DIAMETER (MM)	OPENING ANGLE ± 7°	COLOR CODE	COLOR OF SPRING	CONSTANT (N•MM / DEGREE)
503191247 (Right) 503191249 (Left)	11.0 X 9.25 (rectangular)	90°	WH/YL	BLACK	1.99
503191287 (Right) 503191289 (Left)	9.525 (square)	80°	GN/YL/YL	BLACK	1.44
503191481 (Right) 503191483 (Left)	11.0 x 9.25 (rectangular)	100°	WH/BL	BLACK	2.30
503192080 (Right) 503192081 (Left)	8.85 (square)	80°	-	BLACK	1.27
503192104 (Right) 503192105 (Left)	9.525 (square)	90°	-	BLACK	1.50
503192137 (Right) 503192136 (Left)	9.0 (square)	80°	-	BLACK	1.35
503192270 (Right) 503192271 (Left)	9.86 (square)	80°	-	BLACK	1.66
503193002 (Right) 503193003 (Left)	8.46 (square)	80°	-	BLACK	1.37
503193159 (Right) 503193158 (Left)	9.14 (square)	80°	-	BLACK	1.35
503193538 (Right) 503193539 (Left)	11.0 x 9.25 (Rectangular)	90°	-	BLACK	1.94
503193637 (Right) 503193636 (Left)	8.46 (square)	90°	-	BLACK	1.21
503196053 (Right) 503196052 (Left)	9.14 (square)	82°	-	BLACK	1.52
503196202 (Right) 503196203 (Left)	11.0 x 9.25 (rectangular)	80°	-	BLACK	1.86
503196525 (Right) 503196524 (Left)	9.14 (square)	90°	-	BLACK	1.50
503196942 (Right) 503196941 (Left)	8.46 (square)	95	-	BLACK	1.39

Torsion Springs for SC-5U Suspension (Skandic and Expedition LE/SE/Extreme)

(PART NUMBER)	WIRE DIAMETER (MM)	OPENING ANGLE ± 7°	COLOR OF SPRING	CONSTANT (N•MM / DEGREE)
503192377 (Right) 503192378 (Left)	11 x 9.25 (rectangular)	75°	BLACK	1.92
503192910 (Right) 503192911 (Left)	11 x 11 (square)	75°	BLACK	2.45
503194340 (Right) 503194341 (Left)	11 x 9.25 (rectangular)	90°	BLACK	1.88